

st STARLINE[®]
forged steel ball valves



STARLINE

COMPANY

PROFILE



Since its foundation on 1976 Starline has been focus only on production of Ball Valves in Forged Materials.

After more than 40 years the imprinting philosophy is still present and the base for the company growth and success. Starting from the experience on the floating valves during the years, Starline has developed a wide and complete range of ball valves in different materials and executions introducing Trunnion Mounted design, Single and Double Block and Bleed, Metal to Metal, Cryogenic and High temperature design. Today Starline with a production

capacity of 250.000 valves/year, a complete size range and pressure ratings 1/2" to 36" – class 150- 2500lbs, API6A rate 3000-15000PSI in all the possible configurations and materials, is considered both by customers and other Valve Manufacturers one of the Worldwide Market Leaders in Upstream Oil & Gas Applications which represent more than 70% of the final products destination.

Starline is counting on Worldwide affiliated companies as commercial divisions and distributors which are storing valves for local markets and supporting the end users needs.

PHILOSOPHY

Starline's philosophy is based on the achievement of the standardization of the highest quality requirements in each single product. All materials used are mandatory produced in Western Europe and all forging companies are located in Italy.

A product **FULLY MADE IN ITALY**



REFERENCES

- ADCO
- ADGAS
- ADMA-OPCO
- BP
- DSME
- ENI
- EXXON MOBIL
- GASCO
- GRT GAZ
- GAZPROM
- HYUNDAI (HHI)
- INPEX
- JGC CORPORATION
- KBR
- KNPC
- KOC
- NIOC
- NISOC
- NPCC
- PDO
- PETROBRAS
- PETROFAC
- PTSC
- PTTEP
- QATARGAS
- SAIPEM
- SAMSUNG (SHI)
- SHELL CHEVRON
- SNAMPROGETTI
- STATOIL
- TECHNIP
- TECNIMONT
- TOTAL E&P
- TOYO
- ZADCO



The unique Starline factory, located 40Km north of Milan, includes the office headquarter as well as the production facility. Design of all the products, stock of raw and machined parts, quality control of incoming material, assembly, testing and preparation for shipment are concentrated in this single facility to allow a full control on all the aspects of the production and the complete process.

STANDARDS AND CERTIFICATIONS

- | | |
|----------------------------|-----------------------------------|
| ISO 9001: 2008 | API SPEC Q1 |
| ISO 18001 | API 6DSS |
| ISO 14001 | API 6A |
| PED 2014/68/EU MOD.H CAT.3 | FIRESAFE API607-API 6FA- ISO10497 |
| ATEX 2014/34/EU | BS 6364 |
| SIL 3 | NACE MR0175 – NACE MR0103 |
| CU-TR | SHELL TAT |
| API 6D | ISO 15848 |
| API SPEC Q1 | |



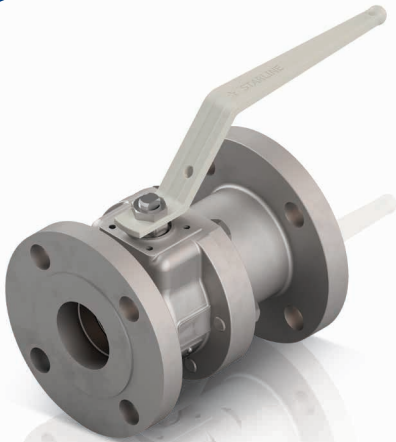

FLOATING BALL VALVES

1/2" to 8" class 150 to 2500 depending on size

FLOATING MOUNTED FORGED STEEL ball valves 2 or 3 pieces bolted construction – FIRE SAFE tested and certified. Materials carbon steel, stainless steel and special alloys.

Fugitive emission ISO 15848-1 rate A or B depending on the execution.



In 'StarlineAR' and DOWNLOAD NOW



Special executions are available according to the customer demands, soft/metal seated, high temperature, cryogenic, heating jackets solutions, particular hub ends.

TRUNNION MOUNTED BALL VALVES

1/2" to 36" class 150 to 2500 - API 3000 - 5000 - 10000 - 15000

TRUNNION MOUNTED FORGED STEEL ball valves 2 or 3 pieces bolted construction – Double Block and Bleed – Single Piston Effect – Double Piston Effect - FIRE SAFE tested and certified. Materials carbon steel, stainless steel and special alloys.

Fugitive emission ISO 15848-1 rate A or rate B depending on the execution.

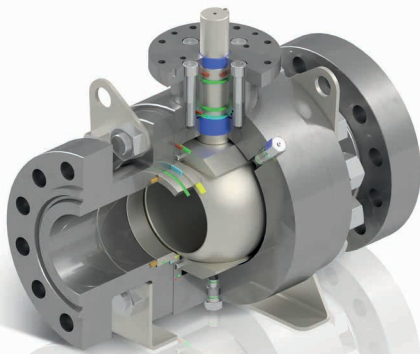

In 'StarlineAR' and DOWNLOAD NOW



SINGLE and DOUBLE BLOCK AND BLEED BALL VALVES

1/2" to 12" class 150 to 2500
1 13/16" to 7 1/16" API3000-5000-10000-5000

FLOATING and TRUNNION MOUNTED FORGED STEEL ball valves 2 or 3 pieces bolted construction – FIRE SAFE tested and certified – bolted needle valve fully protected – suitable for instrumentation, safety and chemical injection application. Materials carbon steel, stainless steel and special alloys. Fugitive emission ISO 15848-1 rate A or B depending on the execution.

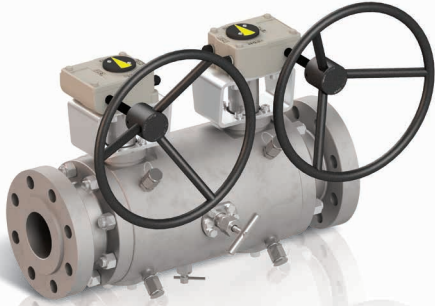

In 'StarlineAR'
and DOWNLOAD NOW



In 'StarlineAR'
and DOWNLOAD NOW



COMPACT BALL VALVES

API pressure classes

TRUNNION MOUNTED FORGED STEEL ball valves 2 or three pieces design - DBB available on request - special end connection available as for example swivel flanges. Materials carbon steel, stainless steel and special alloys.

SUBSEA BALL VALVES

API pressure classes

FLOATING OR TRUNNION MOUNTED FORGED STEEL ball valves 2 or 3 pieces - DBB available on request - stem&body special seals to prevent the ingress of sea water into the valve body. Materials carbon steel, stainless steel and special alloys.

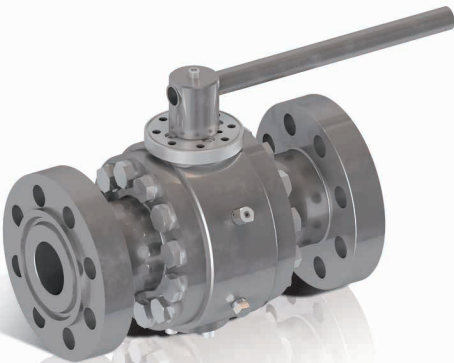

In 'StarlineAR'
and DOWNLOAD NOW



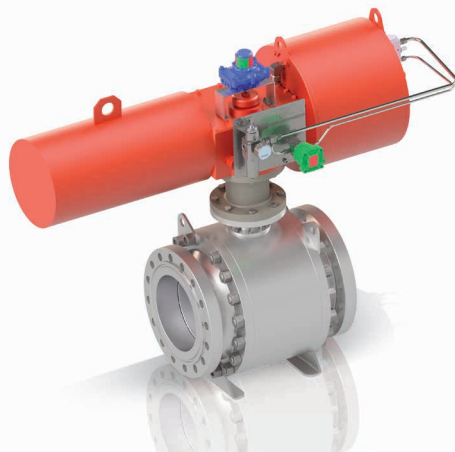

ACTUATED BALL VALVES

Starline is able to provide any kind of actuated ball valves starting from the customer requirement using the most suitable components according to needs (complete system with rack&pinion actuators, scotch&yoke actuators, compact actuators, SOV, AFR, POV, QQEV, positioner etc.). The final control system is built into a control panel designed and manufactured completely by Starline.

The complete system is tested in Starline facilities with a proper FAT according to Starline standards or customer specifications.

Starline personnel is qualified to perform SIL certification on the complete unit.

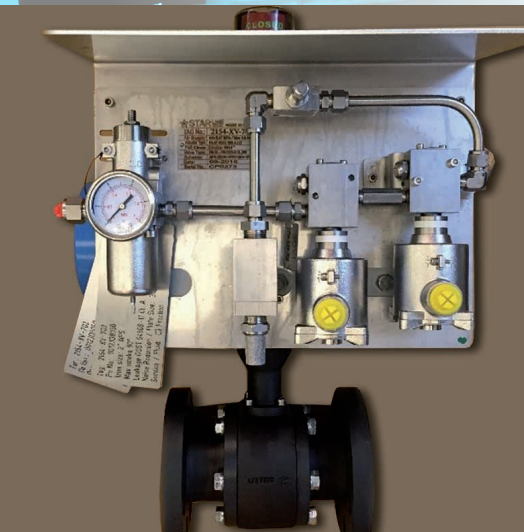
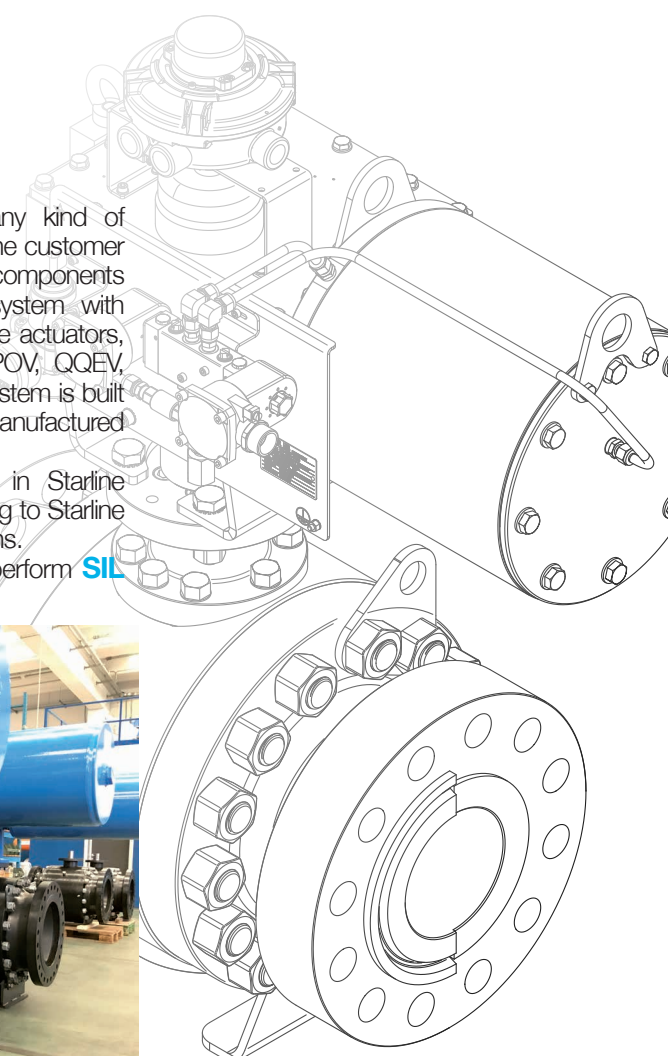

↓
In 'StarlineAR'
and DOWNLOAD NOW

AVAILABLE ON THE
App Store

ANDROID APP ON
Google Play

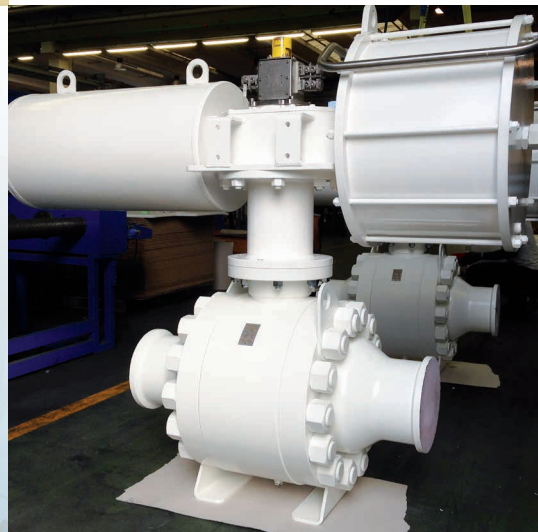



Starline testing area is equipped with multihead benches and separated control stations to test simultaneously many valves or a single one especially for big sizes or to cover special testing procedures. Hydraulic, pneumatic, high pressure gas test and fugitive emission test are performed according to the most recognized specification and according to the specific customer needs.

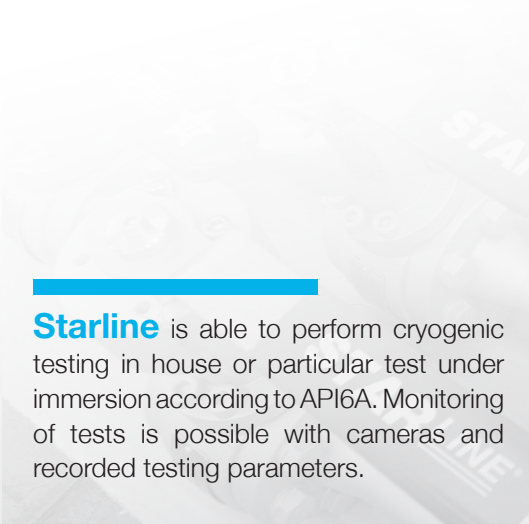
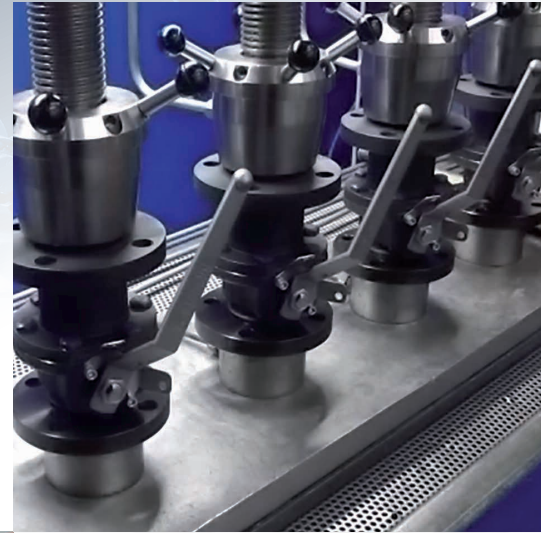

Starline is able to perform cryogenic testing in house or particular test under immersion according to API6A. Monitoring of tests is possible with cameras and recorded testing parameters.

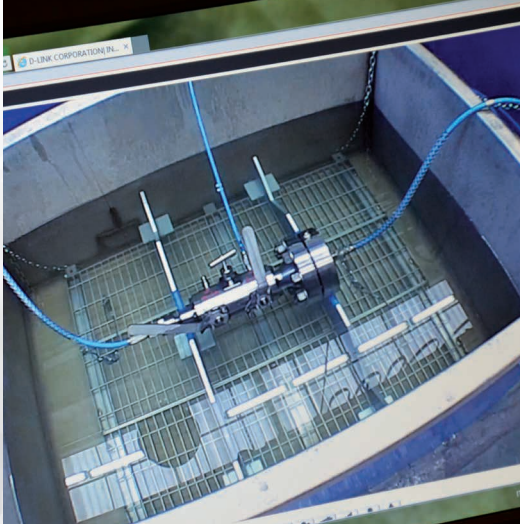

Starline invests every year on instrument and technologies which give the possibility of controlling the quality of each product and its components. Starline performs in its facilities different non-destructive testing like ultrasonic, penetrant test, magnetic particles as defined by ASME B16.34. Starline personnel performing NDT is trained and qualified to EN 473/ ASNT-SNT-TC-1A.





Starline S.p.A. - Società Unipersonale

Via dei Livelli di Sopra, 11 - 24060 Costa di Mezzate (BG) Italy
tel. +39 035 958041 / +39 035 958102 - fax +39 035 958413
www.starline.it - starline@starline.it

STARLINE BALL VALVES Ltd.

Unit 6, Interlink Way South
Bardon Hill, Coalville,
Leicestershire, LE67 1PH
UK
Phone.: +44 (0) 1530 815818
Fax.: +44 (0) 1530 815819
starline@acvalvealliance.com
www.acvalvealliance.com

STARLINE FRANCE S.a.r.l.

7, Parc d'Activités de la Verdrière
13880 Velaux
FRANCE
Phone : +33 (0) 442878400
Fax : +33 (0) 442878404
infos@star-line.fr
www.star-line.fr

STARLINE VALVES OY

Koivuhaantie, 2-4 C
01510 Vantaa
FINLAND
Phone: +358 (0) 98787711
Fax : +358 (0) 98787221
starline@starline.fi
www.starline.fi

**STARLINE S.p.A.
(DMCC Branch) Dubai Office**

30th Floor, Reef Tower, Cluster 'O',
Jumeirah Lake Towers, Dubai,
United Arab Emirates
P.O. Box 123740
Phone : +971 (0) 4 448 7232
Fax : +971 (0) 4 448 7112