

The all-in-one proximity sensor and limit switch.



TopWorx™ GO™ Switch is the most versatile sensing solution. It detects like a proximity switch and functions like a limit switch, providing higher reliability when conventional switches fail.



TopWorx and GO - Global Supply Line is the Agent supplier, distributor and stockist. Global Supply Line is the largest Emerson Scotch Yoke Actuator stockist in the southern hemisphere stocking Bettis & Biffi. Scotch yoke pneumatic actuators up to 30,000NM. Click here for our full stock list at our website: <https://www.globalsupplyline.com.au/stock-list-valves/>
Contact us: admin@globalsupplyline.com.au

A global leader in valve control and proximity sensing.



Emerson is a global leader in valve control and proximity sensing for the process industries. Our Topworx solutions enable plants, platforms, and pipelines to manage and control operations more intelligently and efficiently under the most demanding and extreme conditions.

Global Technology Leadership

The technology advancements in TopWorx products are at the forefront of innovation in the process automation industry. TopWorx products use wireless technologies and fieldbus protocols such as FOUNDATION Fieldbus, DeviceNet, AS-Interface, Profibus, and HART to reduce installation costs and enable predictive maintenance.



Global Hazardous Area Certifications

In addition to high temperature +204 °C (+399 °F), cold temperature -50 °C (-58 °F), and sub-sea 7,010 m (23,000 ft) applications, TopWorx products are suitable for use in Flameproof/Explosion Proof, Non-Incendive, Intrinsically Safe hazardous areas with IECEx, ATEX, GOST, InMetro, UL, CSA, KOSHA, and NEPSI certifications.



Global Service & Support

With company locations in the United States, United Kingdom, South Africa, Bahrain, and Singapore, Emerson is strategically positioned to provide outstanding support. In addition, over 200 Certified Product Partners throughout the world are available to provide competent local support when needed.



High Reliability Applications

GO Switch provides reliable, durable proximity sensing in the most demanding conditions. Using unique technology, GO Switch outperforms all other types of sensors in applications that require high reliability and durability.

Capabilities

- Superior current rating
- Superior pressure rating
- Superior temperature rating
- Superior hazardous area ratings
- Superior resistance to physical abuse
- Superior resistance to corrosives, salt water

With GO Switch, customers enjoy:

- One-of-a-kind technology that offers high current ratings, AC/DC and NO/NC wiring flexibility and non-contact detection of ferrous metal and magnetic targets.
- Global certifications for use in Zone 0 (intrinsically safe), Zone 1 (explosion proof), Zone 2 (non-incendive) Class I, Div. 1 & 2, Class II, Div 1 & 2 and Class III hazardous areas.
- Proven reliability in power generation, chemical, refineries, steel & aluminum, water & wastewater, oil & gas, petrochemical, food & beverage, pulp & paper, heavy equipment, mining, military vehicles, manufacturing, amusement parks, and material handling industries.
- Durability in mission-critical applications in extremely hot, cold, wet, dirty, abusive, corrosive, and explosive environments.



GO™ Switch Capabilities

Common Features & Benefits

Using a unique technology, GO Switch outperforms conventional limit switches and proximity sensors in the toughest applications.

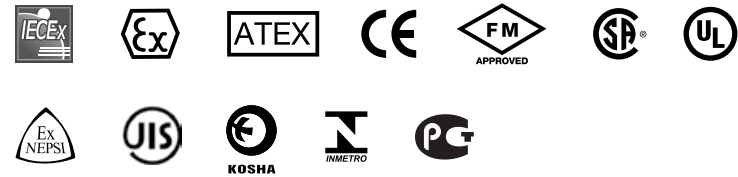

GO Switches offer the following features and benefits:

Features	Solutions
Proximity triggering with ferrous metal and magnetic targets - no exposed moving parts	Eliminate broken or bent lever arms, poor mechanical alignment, and poor repeatability
Extended sensing with use of target magnets	Eliminate the need to purchase/acquire a different device to obtain extended sensing
Immune to electrical noise, weld fields, and radio frequency interference	Eliminate electrical problems common to inductive proximity sensors
Consume no power to operate	Eliminate leakage current and voltage drops
Can be wired AC or DC, N/O or N/C, in series or parallel	Flexibility to cover a variety of application needs with fewer part numbers
All-metal housings with contacts potted and sealed from the environment	Performance is not affected by dust, dirt, moisture, or most caustics, corrosives, or chemicals
Multiple wiring options, including lead wires, cables, quick disconnects, etc.	Easy installation and seamless integration into your existing plant wiring standards
A wide variety of hazardous area certifications for Zone 0, 1, 2 and Class 1 & 2, Div 1 & 2	Compliance with intrinsically safe, explosion proof, and non-incendive requirements
Operating temperatures ranging -50 °C to +204 °C (-58 °F to +400 °F).	Ability to monitor plant processes in areas too hot or too cold for conventional sensors

GO Switch Quick Selection Guide

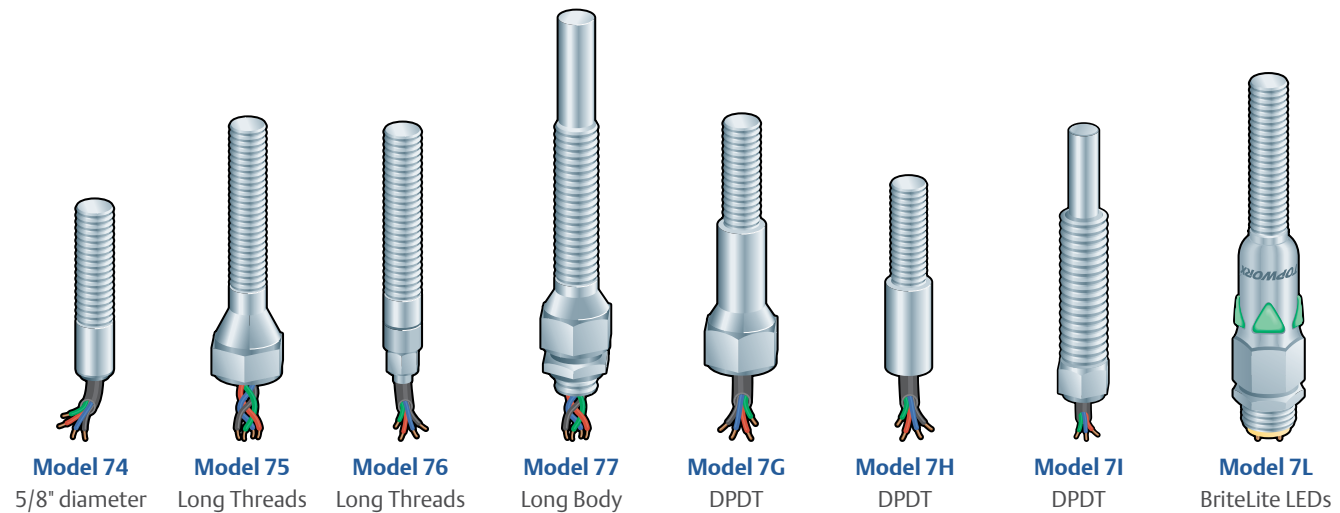
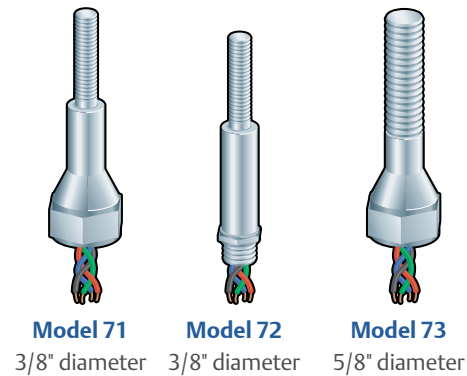
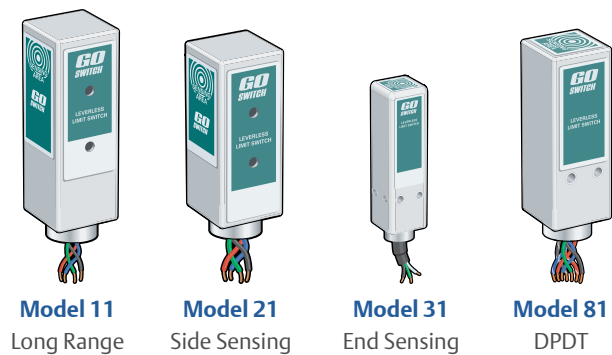

General Purpose	●	●	●	●	●	●	●	●	●	●	●	●	●	●	●
Class I, Div 1	●	●	●	●	●	●	●	●	●	●	●	●	●	●	●
Class I, Div 2	●	●	●	●	●	●	●	●	●	●	●	●	●	●	●
Class II, Div 1	●	●	●	●	●	●	●	●	●	●	●	●	●	●	●
Class II, Div 2	●	●	●	●	●	●	●	●	●	●	●	●	●	●	●
Class III	●	●	●	●	●	●	●	●	●	●	●	●	●	●	●
Zone 0, Intrinsically Safe	●	●	●	●	●	●	●	●	●	●	●	●	●	●	●
Zone 1, Flameproof	●	●	●	●	●	●	●	●	●	●	●	●	●	●	●
Underwater	●	●	●	●	●	●	●	●	●	●	●	●	●	●	●
High Temperature	●	●	●	●	●	●	●	●	●	●	●	●	●	●	●
DPDT			●						●	●	●				

Extended Sensing

Precision Sensing

GO™ Switch-Extended Sensing

Built to last in the most demanding conditions

GO Switch models 11, 21, 31 and 81 are the ideal replacements for traditional mechanical limit switches. Sealed contacts, rugged housings, non-contact detection of ferrous metal & magnetic targets, and snap action response make these switches the ultimate problem solvers for troublesome mechanical limit switch applications.

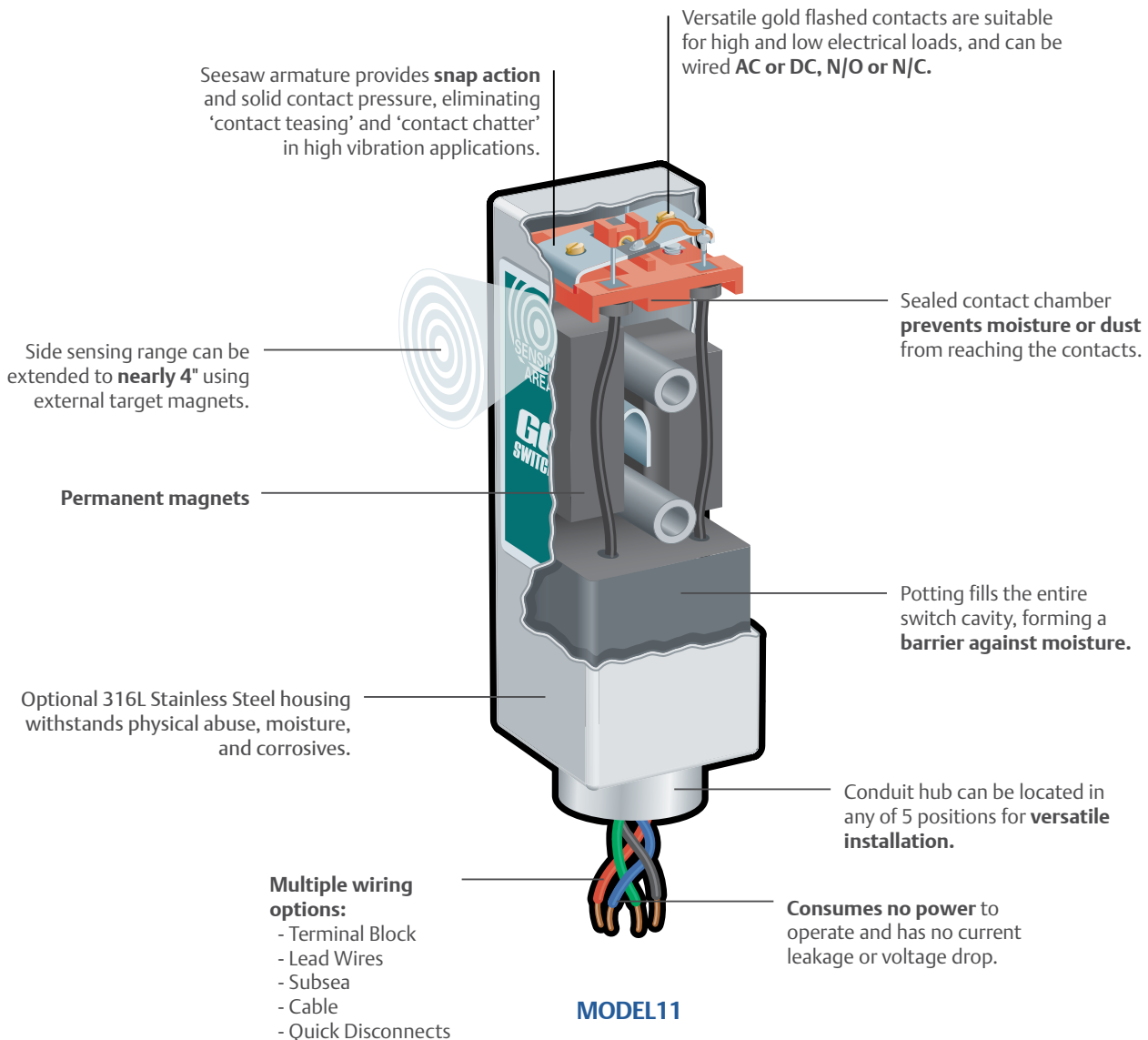

Models 11, 21, 31, and 81 were the world's original GO Switches. Their simple design, rugged housings, long sensing ranges, and global approvals make these switches the ideal choice wherever reliable proximity sensing is needed. Some features common to all these models include a standard operating temperature range of -50 °C to 105 °C (-58 °F to +221 °F) and gold-plated SPDT dry contacts.

Model 11

Features

- Single Pole Double Throw (SPDT)
5A/240VAC, 10A/120VAC, 3A/24VDC
- AC/DC, NO/NC Wiring Flexibility
- -50 °C to 105 °C (-58 °F to +221 °F)
operating temperature
- 10 mm (3/8 in) sensing distance
(ferrous metal)
- Dry Contact
- Intrinsically Safe
- Side sensing
- Gold Plated Contacts

Options

- High Temperature: -50 °C to +176 °C
(-58 °F to +350 °F)
- 316L Stainless Steel Housing
- Extended Sensing: 14 mm (9/16 in)
- Terminal Block, Lead Wires, or Cables
- Latching Contacts
- SubSea Connectors
- Quick Disconnects - Micro or Mini
- Global Hazardous Area Approvals



Model 81

Features

- Double Pole Double Throw (DPDT)
5A/240VAC, 10A/120VAC, 3A/24VDC
- AC/DC, NO/NC Wiring Flexibility
- -50 °C to 105 °C (-58 °F to +221 °F)
operating temperature
- 6 mm (1/4 in) Sensing Distance
(Ferrous metal)
- Dry Contact
- Intrinsically Safe
- End Sensing
- Gold Plated Contacts

Options

- High temperature: -50 °C to +176 °C
(-58 °F to +350 °F)
- Single Pole Double Throw (SPDT)
10A/120VAC, 3A/24VDC
- 316L Stainless Steel Housing
- Lead Wires or Cables
- SubSea Connectors
- Quick Disconnects – Mini
- CSA/UL Hazardous Area Approvals



Model 21

Features

- Single Pole Double Throw (SPDT)
5A/240VAC, 10A/120VAC, 3A/24VDC
- AC/DC, NO/NC Wiring Flexibility
- -50 °C to 105 °C (-58 °F to +221 °F)
operating temperature
- 10 mm (3/8 in) Sensing Distance
(Ferrous Metal)
- Dry Contact
- Intrinsically Safe
- Side sensing
- Gold Plated Contacts

Options

- 316L Stainless Steel Housing
- Terminal Block, Lead Wires, or Cables
- Latching Contacts
- SubSea Connectors
- Quick Disconnects - Micro or Mini
- Global Hazardous Area Approvals



Model 31

Features

- Single Pole Double Throw (SPDT)
3A/240VAC, 6A/120VAC, 2A/24VDC
- AC/DC, NO/NC Wiring Flexibility
- -50 °C to +105 °C (-58 °F to +221 °F)
operating temperature
- 6 mm (1/4 in) Sensing Distance
(Ferrous metal)
- Dry Contact
- Intrinsically Safe
- End sensing
- Gold Plated Contacts

Options

- Stainless Steel Enclosure
- Lead Wires or Cables
- Quick Disconnects - Micro or Mini
- CSA/FM Hazardous Area Approvals



GO™ Switch Ordering Guide - Extended Sensing

Choose one option from each category to build a complete model number.



Model	Contact Form	Sensing Range	Outlet Position	Enclosure Materials	Approvals	Wiring Options
<p>Models 11, 21 & 81</p> <p>✓ 11 1 1/2" square x 4 9/16" overall. (Add 1/2" for bottom conduit outlet)</p> <p>✓ 21 1 1/2" square x 3 13/16" overall. (Add 1/2" for bottom conduit outlet)</p> <p>31 1" square x 3 1/4" overall</p> <p>81 1 1/2" square x 4 3/8" overall. (Add 1/2" for bottom conduit outlet)</p>	<p>✓ 1 Single Pole Double Throw (Form C)</p> <p>✓ 2 Double Pole Double Throw (Form CC) (Model 81 Only)</p> <p>3 Single Pole Double Throw (Form C) Latching (Maintained contact) (Models 11 & 21 only) (Outlet 2, 4 or 5 only)</p> <p>5 Double Make Double Break, two-circuit Form Z (Model 11 Only)</p> <p>6 Double Make Double Break, two-circuit, Form Z Latching (maintained contact) (Model 11 Only)</p>	<p>✓ 0 1/4" end sensing (Model 81 only)</p> <p>✓ 1 Standard sensing - 3/8" side sensing (Model 11 & 21 only)</p> <p>✓ 2 Extended sensing - 9/16" side sensing (Contact form must be 1 or 3) (Model 11 only)</p> <p>7 Precision sensing - 1/4" side sensing (Minimal differential) (Models 11, 21 & 31 only)</p>	<p>1 Behind sensing area (Models 11, 21 & 81 only)</p> <p>2 Left of sensing area (Models 11 & 21 only)</p> <p>3 Right of sensing area (Models 11 & 21 only)</p> <p>4 Same side as sensing area (Models 11 & 21 only)</p> <p>5 Bottom of enclosure</p>	<p>✓ 1 Standard enclosure</p> <p>✓ 2 316L Stainless steel*</p> <p>* All-welded stainless steel switches are recommended for wet or harsh environments.</p>	<p>✓ - CSA / FM Cl I, Div 2, Grps A-D; Cl II, Div 1 & 2, Grps E-G, Cl III</p> <p>- High temperature to 176 °C (350 °F)</p> <p>- UL Cl I, Div 1; Grps A-D; Cl II, Div 1 Grps E-G; Cl III</p> <p>✓ - CSA / FM Cl I, Div 1; Grps A-D; Cl II, Div 1; Grps E-G; Cl III</p> <p>✓ - CSA / FM Cl I, Div 2; Grps A-D; Cl II, Div 2; Grps F,G; Cl III</p> <p>- cUL Certified General Purpose</p> <p>✓ - UL General Purpose</p> <p>- ATEX/IECEx Zone 0 Ex ia IIC T6 Ga, Ex ia IIIC T85 °C Da, (-40 °C≤Ta≤50 °C) (Wiring must be 5 or 00/00M) (Models 11, 21 & 81 only)</p> <p>- ATEX/IECEx Zone 0 Ex ia IIC T4 Ga, Ex ia IIIC T135 °C Da, (-40 °C≤Ta≤100 °C)</p> <p>- ATEX/IECEx Zone 0 Ex ia IIC T3 Ga, Ex ia IIIC T 200°C Da, (-40 °C≤Ta≤150 °C)</p> <p>*Regional Certifications Available</p> <p>*Approvals are model specific. Please contact your TopWorx distributor or consult the price guide to build a part number with specific approval.</p>	<p>✓ Terminal Block (Models 11 and 21 only)</p> <p>00 1/2"- 14 NPT</p> <p>00M M20</p> <p>✓ Lead Wires - 18 Gauge, PVC insulated</p> <p>A2 3'</p> <p>A3 6'</p> <p>A4 12'</p> <p>A5 25'</p> <p>A6 50'</p> <p>A7 100'</p> <p>A8 250'</p> <p>Cable - 16 Gauge, SO rubber insulated</p> <p>B2 3'</p> <p>B3 6'</p> <p>B4 12'</p> <p>B5 25'</p> <p>B6 50'</p> <p>B7 100'</p> <p>B8 250'</p> <p>Mini Change Connector (Models 11, 21, 31 & 81) (Approval 7 or 8 only)</p> <p>DCA 3 pin</p> <p>DCD 4 pin</p> <p>DCH 7 pin (Model 81 only)</p> <p>Quick Disconnect M12x1 (Area Classification must be 7 or 8) (Models 11, 21 & 31 only)</p> <p>DMD 4 pin</p> <p>SubSea Connector (Models 11, 21 & 81) (Enclosure 2 or 4 only) (Approval 7 or 8 only)</p> <p>3DD 3 pin</p> <p>4DD 4 pin</p> <p>8DD 8 pin (Model 81 only)</p> <p>3DE 3 pin 90°</p> <p>4DE 4 pin 90°</p> <p>Hi-Temp Lead Wires - 18 Gauge, Teflon™ insulated</p> <p>F2 3'</p> <p>F3 6'</p> <p>F4 12'</p> <p>F5 25'</p> <p>F6 50'</p> <p>F7 100'</p> <p>F8 250'</p> <p>Cable- 18 Gauge Blue Silicone (Area Classification must be F, G or H) (Models 11, 21 & 81 only)</p> <p>S2 3'</p> <p>S3 6'</p> <p>S4 12'</p> <p>S5 25'</p> <p>S6 50'</p> <p>S7 100'</p> <p>S8 250'</p> <p>* Wiring options are model specific. Please contact your TopWorx distributor to select a specific wiring option.</p>
<p>Ordering Guide</p> <p>Fill in each box to create a complete model number.</p>						
Model	Contact Form	Sensing Range	Outlet Position	Enclosure Materials	Approvals	Wiring Options

GO™ Switch - Precision Sensing

Built to last in the most demanding conditions

With all stainless steel construction, flexible AC/DC, NO/NC, and SPDT/DPDT contact configurations, superior corrosion resistance, and global certifications for all hazardous areas, 70 Series GO Switches outperform inductive proximity switches in the toughest applications.

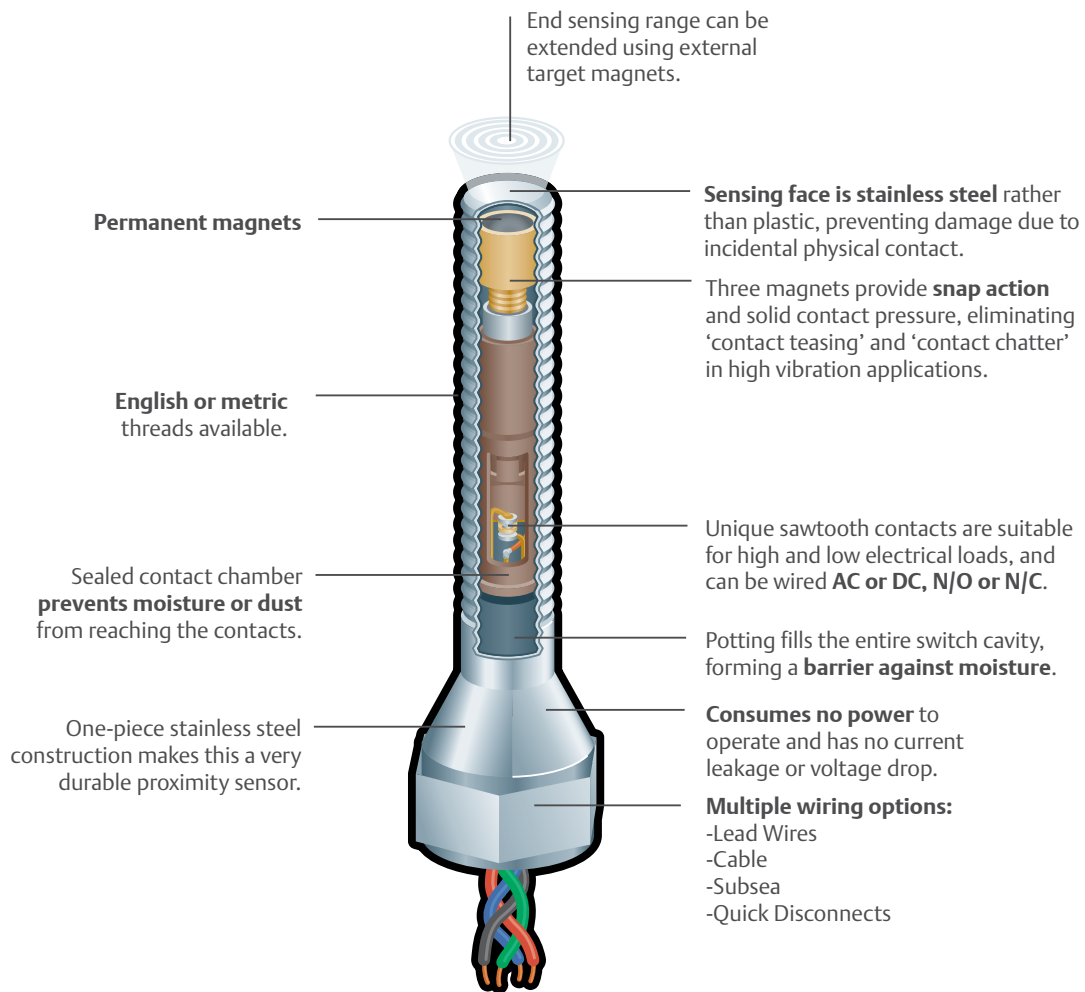

MODEL 73

All 70 Series Models

Temperature Rating:

71-77: -40 °F (-40 °C) to +221 °F (+105 °C) Std.*

71-77, 7G, 7H: HiTemp to +400 °F (+204 °C)*

7L: -40 °F (-40 °C) to +160 °F (+71 °C)*

* Reference certificates for variations to temperature rating.



Model 71

Features

- Single Pole Double Throw (SPDT)
2A/240VAC, 4A/120VAC, 3A/24VDC
- AC/DC, NO/NC Wiring Flexibility
- -50 °C to +105 °C (-58 °F to +221 °F)
operating temperature
- 1 mm (0.040 in) Sensing Distance
(Ferrous metal)
- Dry Contact
- Intrinsically Safe
- End Sensing
- Palladium Silver Contacts
- Stainless Steel 316L Housings

Options

- High Temperature: -50 °C to +204 °C
(-58 °F to +400 °F)
- Lead Wires or Cables
- Quick Disconnects – Micro
- 3/8" or M12 metric thread
- Global Hazardous Area Approvals



Model 72

Features

- Single Pole Double Throw (SPDT)
2A/240VAC, 4A/120VAC, 3A/24VDC
- AC/DC, NO/NC Wiring Flexibility
- -50 °C to +105 °C (-58 °F to +221 °F)
operating temperature
- 1 mm (0.040 in) Sensing Distance
(Ferrous metal)
- Dry Contact
- Intrinsically Safe
- End Sensing
- Palladium Silver Contacts
- Stainless Steel 316L Housings

Options

- High Temperature: -50 °C to +204 °C
(-58 °F to +400 °F)
- Lead Wires or Cables
- Quick Disconnects – Micro
- 3/8" or M12 metric thread
- ATEX/IECEx Hazardous area approvals



Model 73

Features

- Single Pole Double Throw (SPDT)
2A/240VAC, 4A/120VAC, 3A/24VDC
- AC/DC, NO/NC Wiring Flexibility
- -50 °C to +105 °C (-58 °F to +221 °F)
operating temperature
- 2.5 mm (0.100 in) Sensing Distance
(Ferrous metal)
- Dry Contact
- Intrinsically Safe
- End Sensing
- Palladium Silver Contacts
- Stainless Steel 316L Housings

Options

- High Temperature: -50 °C to +204 °C
(-58 °F to +400 °F)
- Pressure Rating: 2,000
5,000, 10,000 PSI, (140, 345, 690 bars)
- Lead Wires or Cables
- SubSea Connectors
- Hermetic Seal
- Quick Disconnects – Micro or Mini
- 5/8" or M18 metric thread
- Global Hazardous Area Approvals



Model 74

Features

- Single Pole Double Throw (SPDT)
2A/240VAC, 4A/120VAC, 3A/24VDC
- AC/DC, NO/NC Wiring Flexibility
- -50 °C to +105 °C (-58 °F to +221 °F)
operating temperature
- 2.5 mm (0.100 in) Sensing Distance
(Ferrous metal)
- Dry Contact
- Intrinsically Safe
- End Sensing
- Palladium Silver Contacts
- Stainless Steel 316L Housings

Options

- High Temperature: -50 °C to +204 °C
(-58 °F to +400 °F)
- Pressure Rating: 2,000, 5,000, 10,000 PSI
(140, 240, 690 bars)
- Lead Wires or Cables
- Water Resistant Squeeze Connectors
- Quick Disconnects – Micro
- 5/8" or M18 metric thread
- ATEX/IECEx Hazardous Area Approvals

GO™ Switch - Precision Sensing

Built to last in the most demanding conditions



Model 75

Features

- Single Pole Double Throw (SPDT)
2A/240VAC, 4A/120VAC, 3A/24VDC
- AC/DC, NO/NC Wiring Flexibility
- -50 °C to +105 °C (-58 °F to +221 °F)
operating temperature
- 2.5 mm (0.100 in) Sensing Distance
(Ferrous metal)
- Dry Contact
- Intrinsically Safe
- End Sensing
- Palladium Silver Contacts

Options

- High Temperature: -50 °C to +204 °C
(-58 °F to +400 °F)
- Stainless Steel or 316 Housings
- Pressure Rating: 2,000, 5,000, 10,000 PSI
(140, 240, 690 bars)
- Lead Wires or Cables
- SubSea Connectors
- Hermetic Seal
- Quick Disconnects – Micro or Mini
- 5/8" or M18 metric thread
- Global Hazardous Area Approvals



Model 76

Features

- Single Pole Double Throw (SPDT)
2A/240VAC, 4A/120VAC, 3A/24VDC
- AC/DC, NO/NC Wiring Flexibility
- -50 °C to +105 °C (-58 °F to +221 °F)
operating temperature
- 2.5 mm (0.100 in) Sensing Distance
(Ferrous metal)
- 316L Stainless Steel Housings
- Dry Contact
- Intrinsically Safe
- End Sensing
- Palladium Silver Contacts

Options

- High Temperature: -50 °C to +204 °C
(-58 °F to +400 °F)
- Pressure Rating: 2,000, 5,000, 10,000 PSI
(140, 240, 690 bars)
- Lead Wires or Cables
- Water Resistant Squeeze Connectors
- Quick Disconnects – Micro
- 5/8" or M18 metric thread



Model 7A

Features

- 3.5 SCFM nominal flow rate
- 60 PSI (4 bars) max air supply
- -40 °C to +105 °C (-40 °F to +221 °F)
operating temperature
- 1.5 mm (0.062 in) Sensing Distance
(Ferrous metal)
- End Sensing
- Stainless Steel 303 Housing
- 5/8" Thread
- Plunger

Options

- 303 Stainless Steel base



Model 7H

Features

- Double Pole Double Throw (DPDT)
1.5A/240VAC, 3A/120VAC, 1A/24VDC
- AC/DC, NO/NC Wiring Flexibility
- -50 °C to +105 °C (-58 °F to +221 °F)
operating temperature
- 2.3 mm (0.090 in) Sensing Distance
(Ferrous metal)
- 316L Stainless Steel Housings
- Dry Contact
- Intrinsically Safe
- End Sensing
- Palladium Silver Contacts

Options

- High Temperature: -50 °C to +204 °C
(-58 °F to +400 °F)
- Lead Wires or Cables
- Quick Disconnects – Mini
- 5/8" thread



Model 7G

Features

- Double Pole Double Throw (DPDT)
1.5A/240VAC, 3A/120VAC, 1A/24VDC
- AC/DC, NO/NC Wiring Flexibility
- -50 °C to +105 °C (-58 °F to +221 °F)
operating temperature
- 2.3 mm (0.090 in) Sensing Distance
(Ferrous metal)
- 316L Stainless Steel Housings
- Dry Contact
- Intrinsically Safe
- End Sensing
- Palladium Silver Contacts

Options

- Single Pole Double Throw (SPDT)
2A/240VAC, 4A/120VAC, 1A/24VDC
- High Temperature: -50 °C to +204 °C
(-58 °F to +400 °F)
- Lead Wires or Cables
- Hermetic Seal
- Quick Disconnects – Mini
- 5/8" or M18 metric thread
- Global Hazardous Area Approvals



Model 7I

Features

- Double Pole Double Throw (DPDT)
1.5A/240VAC, 3A/120VAC, 1A/24VDC
- AC/DC, NO/NC Wiring Flexibility
- -50 °C to +105 °C (-58 °F to +221 °F)
operating temperature
- 2.3 mm (0.090 in) Sensing Distance
(Ferrous metal)
- 316L Stainless Steel Housings
- Dry Contact
- Intrinsically Safe
- End Sensing
- Palladium Silver Contacts

Options

- High Temperature: -50 °C to +204 °C
(-58 °F to +400 °F)
- Lead Wires or Cables
- Quick Disconnects – Mini
- 5/8" thread
- Global Hazardous Area Approvals



Model 77

Features

- Single Pole Double Throw (SPDT),
2A/240VAC, 4A/120VAC, 3A/24VDC
- AC/DC, NO/NC Wiring Flexibility
- -50 °C to +105 °C (-58 °F to +221 °F)
operating temperature
- 2.5 mm (0.100 in) Sensing Distance
(Ferrous metal)
- 316L Stainless Steel Housings
- Dry Contact
- Intrinsically Safe
- End Sensing
- Palladium Silver Contacts

Options

- High Temperature: -50 °C to +204 °C
(-58 °F to +400 °F)
- Pressure Rating: 2,000, 5,000, 10,000 PSI
(140, 240, 690 bars)
- Lead Wires or Cables
- SubSea Connectors
- Quick Disconnects – Micro or Mini
- 5/8" or M18 metric thread
- Global Hazardous Area Approvals



Model 7L

Features

- Single Pole Double Throw (SPDT)
0.25A/120VAC, 0.25A/24VDC
- AC/DC, NO/NC Wiring Flexibility
- -40 °C to +71 °C (-40 °F to +160 °F)
operating temperature
- 2.5 mm (0.100 in) Sensing Distance
(Ferrous metal)
- End Sensing
- Stainless Steel 316 Housing
- Palladium Silver Contacts

Options

- Lead Wires or Cables
- Quick Disconnects – Mini or Micro
- 5/8" thread
- CSA/UL Hazardous Area Approvals

GO™ Switch Ordering Guide - Precision Sensing

Choose one option from each category to build a complete model number.

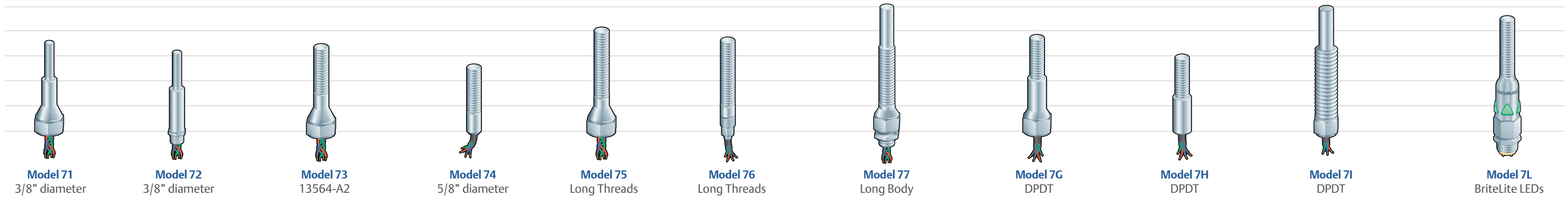

Model	Contact Form	Sensing Range	Outlet Position	Enclosure Materials	Approvals	Wiring Options																																																																																								
71 3/8" x 3 15/16" - 1/2" NPT conduit 71M 12M x 100mm - M20 Conduit Entry <input checked="" type="checkbox"/> 72 3/8" x 3 3/8" - No conduit 72M 12M x 86mm - No conduit 73 5/8" x 3 5/8" - 1/2" NPT conduit 73M 18M x 92mm - M20 Conduit Entry 74 5/8" x 2 3/4" - No conduit 74M 18M x 70mm - No conduit 75 5/8" x 4 5/16" - 1/2" NPT conduit 75M 18M x 110mm - M20 Conduit Entry 76 5/8" x 3 3/16" - No conduit 76M 18M x 81mm - No conduit hub 77 3/4" x 5 13/16" - 1/2" NPT conduit 7G 5/8" x 4" - 1/2" NPT conduit 7GM 18M x 102mm - M20 Conduit Entry 7H 5/8" x 3 1/4" - No conduit 7I 1" x 5 5/8" - 1/2" NPT conduit 7LG 5/8" x 4 3/4" - 1/2" NPT conduit 7LR 5/8" x 4 3/4" - 1/2" NPT conduit	<input checked="" type="checkbox"/> 1 Single Pole Double Throw (Form C) 2 Double Pole Double Throw (Form CC) (Model 7G, 7GM, 7H, & 7I only)	<input checked="" type="checkbox"/> 3 Standard sensing - .100" end sensing 4 .072" end sensing (Models 73, 75, 77, 74, 76, 73M, 74M, 75M, 76M, 77M only) 5 .060" end sensing (Models 73, 75, 77, 74, 76, 73M, 74M, 75M, 76M, 77M; Approvals 2, 7, or 8) 6 .040" end sensing (Models 71 & 72 only)	<input checked="" type="checkbox"/> 5 Bottom of enclosure 2 Side entry with (Approval must be 2 or 8 and Wiring must be F) * For select Models only	<input checked="" type="checkbox"/> 6 316L stainless steel	<ul style="list-style-type: none"> - HiTemp to 400°F - UL CI I, Div 1, Grps A-D; CI II, Div 1, Grps E-G; CI III <input checked="" type="checkbox"/> - cULus CI I, Div 1, Grps A-D; CI II, Div 1, Grps E-G; CI III - UL CI I, Div 2; Grps A-D; CI II, Div 2; Grps F-G; CI III - cUL General Purpose - UL General Purpose - ATEX/IEC Ex Zone 1 Ex db IIC T6 Gb, Ex tb IIIC T85°C Db, IP66 (-40°C ≤ Ta ≤ 50°C) Ex db IIC T4 Gb, Ex tb IIIC T135°C Db, IP66 (-40°C ≤ Ta ≤ 100°C) Ex db IIC T3 Gb, Ex tb IIIC T200°C Db, IP66 (-40°C ≤ Ta ≤ 150°C) - ATEX/IEC Ex Zone 1 Ex db IIC T6 Gb, Ex tb IIIC T85°C Db, IP66 (-40°C ≤ Ta ≤ 50°C) Ex db IIC T4 Gb, Ex tb IIIC T135°C Db, IP66 (-40°C ≤ Ta ≤ 100°C) Ex db IIC T3 Gb, Ex tb IIIC T200°C Db, IP66 (-40°C ≤ Ta ≤ 150°C) - ATEX/IEC Ex Zone 0Ex ia IIC T6 Ga Ex iD IIIC T85C Da (-40°C ≤ Ta ≤ 50°C) - ATEX/IEC Ex Zone 0, Ex ia IIC T4 Ga, Ex iD IIIC T135C Da (-40°C ≤ Ta ≤ 100°C) - ATEX/IEC Ex Zone 0, Ex ia IIC T3 Ga (-40°C ≤ Ta ≤ 150°C) <p>Temperature ranges are dependent on model and wiring type, final cert may differ. Kindly consult TopWorx</p> <p>More certifications available - consult TopWorx for a full list of Global and Regional Approvals</p> <p>* Approvals are model specific. Please contact your TopWorx distributor or consult the price guide to build a part number with specific approval.</p> <p>** Note: Lead seal not req'd for hermetically sealed contacts (Contact Form 1).</p>	<input checked="" type="checkbox"/> Lead Wires - 18 Gauge, PVC insulated (DPDT- 20 Gauge) <table border="1"> <tr> <td>A2</td> <td>A3</td> <td>A4</td> <td>A5</td> <td>A6</td> <td>A7</td> <td>A8</td> </tr> <tr> <td>3'</td> <td>6'</td> <td>12'</td> <td>25'</td> <td>50'</td> <td>100'</td> <td>250'</td> </tr> </table> <p>Cable - 18 Gauge (DPDT = 22 gauge)</p> <table border="1"> <tr> <td>B2</td> <td>B3</td> <td>B4</td> <td>B5</td> <td>B6</td> <td>B7</td> <td>B8</td> </tr> <tr> <td>3'</td> <td>6'</td> <td>12'</td> <td>25'</td> <td>50'</td> <td>100'</td> <td>250'</td> </tr> </table> <p>Water Resistant Squeeze Connector (Models 72, 74, 76 only) (Approval 7 or 8 only)</p> <table border="1"> <tr> <td>C2</td> <td>C3</td> <td>C4</td> <td>C5</td> <td>C6</td> <td>C7</td> <td>C8</td> </tr> <tr> <td>3'</td> <td>6'</td> <td>12'</td> <td>25'</td> <td>50'</td> <td>100'</td> <td>250'</td> </tr> </table> <p>Mini Change Connector (Models 71, 73, 75, 77, 7G only) (Approval 7 or 8 only; 3 pin is 8 only)</p> <table border="1"> <tr> <td>DCA</td> <td>D8</td> </tr> <tr> <td>3 pin</td> <td>8 pin</td> </tr> </table> <p>DCA 3 pin DCD 4 pin</p> <p>Micro Change Connector (Models 72, 74, 76) (Approval 7 or 8 only; 3 pin is 8 only)</p> <table border="1"> <tr> <td>DBA</td> <td>DBD</td> </tr> <tr> <td>3 pin</td> <td>4 pin</td> </tr> </table> <p>DBA 3 pin DBD 4 pin</p> <p>SubSea Connector (Models 73, 75, 77) (Approval 7 or 8 only; 3 pin is 8 only)</p> <table border="1"> <tr> <td>3DD</td> <td>4DD</td> <td>8DD</td> <td>3DE</td> <td>4DE</td> </tr> <tr> <td>3 pin</td> <td>4 pin</td> <td>8 pin (7G only)</td> <td>3 pin 90°</td> <td>4 pin 90°</td> </tr> </table> <p>Hi-Temp Leads (Teflon™ insulated) 18 Gauge (DPDT = 20 gauge)</p> <table border="1"> <tr> <td>F2</td> <td>F3</td> <td>F4</td> <td>F5</td> <td>F6</td> <td>F7</td> <td>F8</td> </tr> <tr> <td>3'</td> <td>6'</td> <td>12'</td> <td>25'</td> <td>50'</td> <td>100'</td> <td>250'</td> </tr> </table> <p>Hi-Temp Leads (Peek insulated) (Models 71-77)</p> <table border="1"> <tr> <td>H2</td> <td>H3</td> <td>H4</td> <td>H5</td> <td>H6</td> <td>H7</td> <td>H8</td> </tr> <tr> <td>3'</td> <td>6'</td> <td>12'</td> <td>25'</td> <td>50'</td> <td>100'</td> <td>250'</td> </tr> </table> <p>* Raychem, Silicone (Blue) and other QDC options available. ** Wiring options are model specific. Please contact your TopWorx distributor to select a specific wiring option.</p>	A2	A3	A4	A5	A6	A7	A8	3'	6'	12'	25'	50'	100'	250'	B2	B3	B4	B5	B6	B7	B8	3'	6'	12'	25'	50'	100'	250'	C2	C3	C4	C5	C6	C7	C8	3'	6'	12'	25'	50'	100'	250'	DCA	D8	3 pin	8 pin	DBA	DBD	3 pin	4 pin	3DD	4DD	8DD	3DE	4DE	3 pin	4 pin	8 pin (7G only)	3 pin 90°	4 pin 90°	F2	F3	F4	F5	F6	F7	F8	3'	6'	12'	25'	50'	100'	250'	H2	H3	H4	H5	H6	H7	H8	3'	6'	12'	25'	50'	100'	250'
A2	A3	A4	A5	A6	A7	A8																																																																																								
3'	6'	12'	25'	50'	100'	250'																																																																																								
B2	B3	B4	B5	B6	B7	B8																																																																																								
3'	6'	12'	25'	50'	100'	250'																																																																																								
C2	C3	C4	C5	C6	C7	C8																																																																																								
3'	6'	12'	25'	50'	100'	250'																																																																																								
DCA	D8																																																																																													
3 pin	8 pin																																																																																													
DBA	DBD																																																																																													
3 pin	4 pin																																																																																													
3DD	4DD	8DD	3DE	4DE																																																																																										
3 pin	4 pin	8 pin (7G only)	3 pin 90°	4 pin 90°																																																																																										
F2	F3	F4	F5	F6	F7	F8																																																																																								
3'	6'	12'	25'	50'	100'	250'																																																																																								
H2	H3	H4	H5	H6	H7	H8																																																																																								
3'	6'	12'	25'	50'	100'	250'																																																																																								
Ordering Guide Fill in each box to create a complete model number.																																																																																														
Model	Contact Form	Sensing Range	Outlet Position	Enclosure Materials	Approvals	Wiring Options																																																																																								

GO™ Switch Specialty Sensors

Sensing Solutions for Process and Factory Automation

Discrete valve control sensors

35 Series GO Switches have set the standard for reliable performance in valve monitors. With hermetically sealed contacts, low hysteresis, and superior resistance to vibration, moisture, contaminants, and temperature extremes, the 35 Series clearly outperforms any other valve monitoring switch or sensor available. When ordering valve position monitors and switchboxes, be sure to specify **GO Switch**.

Features

- AC/DC, NO/NC flexibility
- Intrinsically safe
- Hermetically sealed contacts

Options

- SPDT rated 4A/120VAC and 3A/24VDC (Copper coated with flat black lacquer)
- DPDT rated 4A/120VAC and 3A/24 VDC (Stainless steel housing)



GO switches for TopWorx valve controllers
Hermetically Sealed DPDT Contacts
Stainless Steel Housing

Hydraulic/pneumatic cylinder end-of-stroke sensors

Stroke-To-GO cylinder proximity sensors provide precise end-of-stroke position indication on pneumatic and hydraulic cylinders. Designed to exceed automotive industry standards, the housing is machined from stainless steel bar stock to handle pressures to 3,000 PSI (206 bars) operating (tested to UL's 4X burst requirement) while withstanding the extreme external conditions such as weld slag, coolants, cutting fluids, physical abuse and even high temperatures. Stroke-to-GO incorporates the same 70 Series GO Switch mechanism that has been proven in the field in the most rigorous applications. This unique design offers the greatest benefits in cylinder position end-of-stroke indication.

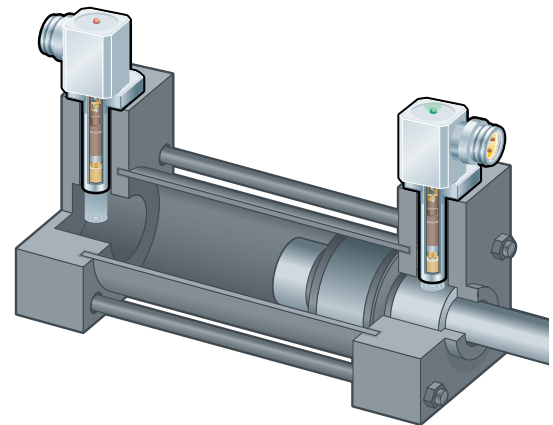

Features

- SPST or SPDT contacts
- AC/DC, NO/NC flexibility
- Stainless steel housings
- 3,000 psi (206 bars) operating pressure
- -50 °C to +105 °C (-58 °F to +221 °F) operating temperature
- 360° adjustable

Options

- -50 °C to +204 °C (-58 °F to +400 °F) high temperature
- Quick disconnect connector
- Underwater capabilities
- LED indication



High temperature sensors

GO Switch HiTemp sensors are rated for continuous operation in temperatures up to 204 °C (400 °F). This proves especially useful in steam turbines as well as other high heat applications such as driers, boilers, aluminum die-casting, steel processing and valve position monitoring on steam valves.



70 Series junction head

GO Switch models 71, 73, 75, 77, 7G, and 7I are available with a junction head option. The junction head carries an ATEX/IECEX 'e' coding. Combined with the GO Switch's ATEX/IECEX 'd' coding, the complete GO Switch, junction head assembly carries an Ex 'de' coding. The Ex 'de' coding gives the GO Switch, junction head assembly an increased safety rating helping to reduce installation costs in Zone 1 hazardous areas. This option allows for termination directly into the switch.



Features

- Light-weight aluminum and stainless steel junction heads
- -40 °C to 100 °C (-40 °F to 212 °F) operating temperature
- Intrinsically safe
- Zone 1, Ex 'de'

Pneumatic valve

GO Switch Model 7A is a pneumatic valve designed to work with a 60 PSI air pilot signal. Incorporating the same GO Switch technology found in our popular model 70 series GO Switches, the 7A offers reliable pneumatic control in air logic systems. The 7A uses three permanent magnets and a push-pull plunger assembly to control a poppet. The switch operates with a snap-action response and low hysteresis, providing precision airline switching. This unique technology allows for non-contact detection of ferrous metal and magnetic targets to switch from the outlet port to the exhaust port.



Features

- 3-port design (P = Supply, A = Outlet Port, E = Exhaust)
- 1.5 mm (0.062 in) Sensing distance (Ferrous metal)
- -40 °C to +105 °C (-40 °F to +221 °F) operating temperature
- Intrinsically safe
- Operates small cylinders
- 60 PSI (4 bars) max air supply
- 3.5 SCFM nominal flow rate

Submersible sensors

GO Switch submersible sensors are submersible up to depths of 7,010m/23,000ft and offer trouble-free position sensing in applications such as offshore oil platforms, lock and dam gates, ships and vessels, pin placement detection, wastewater rendering areas, bilge level, high pressure washdown, draw bridges and subsea valve position monitoring.



GO™ Switch Power Plant Solutions

Sensing Solutions for the Power Generation Industry

GO Switches are the ideal solution for troublesome mechanical limit switch applications in power plants, including coal and ash handling equipment, soot blowers and wall blowers, dampers, igniters, feedwater heaters, hopper valves, water demineralization valves, and scrubber valves.

DEFENDER™ turbine trip monitors

In the power generation industry, reliability is a must. This is especially true when it comes to turbine control valves. But one of the more common difficulties in power plants is the typical limit switch arrangement on throttle, governor, intercept, and reheat stop valves. Conventional limit switches in this application are notorious for failing due to heat and physical abuse, and for falling out of tolerance and requiring readjustment.

The Defender provides dependable monitoring of throttle, governor, intercept, and reheat stop valves.

It is a self-contained, pre-wired system packed with up to ten GO Switches and is a drop-in replacement for existing limit switches on Westinghouse valves, and is easily adaptable to valves from General Electric and others.

Features

- Easy switch setting
- Switches rated to 204 °C (400 °F)
- Mil spec quick disconnect
- Heavy duty 11 Guage Steel (12"x10"x5")

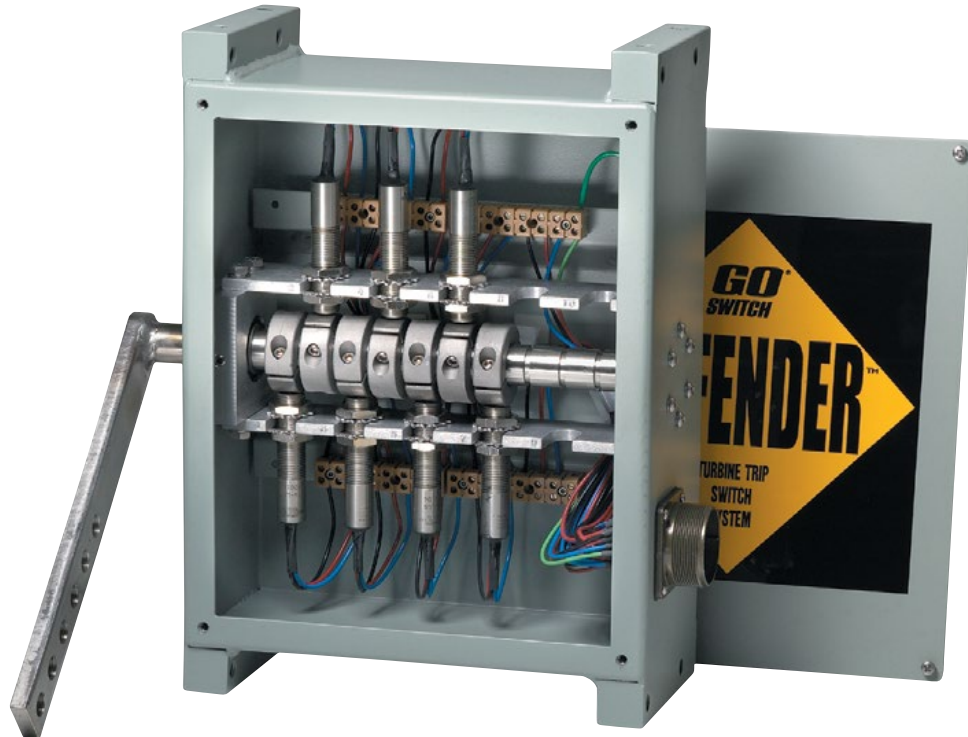

TURBINE TRIP MONITOR SWITCH SYSTEM

TopWorx GO nuclear qualified sensors

GO Switch Nuclear Globally Qualified Sensors are designed for maximum, long-life dependability in Containment LOCA, Containment Non-LOCA (Harsh Duty), and Mild Duty applications. Unique and robust, the GO Switch is a “Set and Forget” sensor that will replace and exceed the operation and reliability of lever arm mechanical switches in Nuclear and Commercial applications.

Advantages of GO Switch Nuclear Qualified Sensors

- By far the highest, most up to date environmental qualifications for qualified life, temperature, pressure, seismic and radiation
- Direct replacement for most mechanical switch applications
 - Contact output N/O N/C AC or DC
- No physical contact is required
- Only one internal moving part
- No lever arm to adjust
- Not affected by most caustics or chemicals
- Water-proof/submersible options
- Explosion-proof options
- Not influenced by RFI and EMC



Quick Disconnects & Cordsets

Quality-engineered connectors and cordsets make installation and maintenance a snap. Standard designs are shown, with custom connectors available on special order. Refer to the Wiring Options portion of each GO Switch Ordering Guide for detailed information.

Micro Change™ Quick Disconnect

22 gauge (3 pin .23" dia.; 4 pin .25 dia.; 5 pin .26 dia.) molded PVC anodized aluminum shell rated 105 °C (221 °F) 300V

Available on all GO Switches



Mini Change™ Quick Disconnect

16 gauge (3 pin .41" dia.; 4 pin .44" dia.; 5 pin .52" dia.; 7 pin .54 dia.) molded PVC anodized aluminum shell rated 105 °C (221 °F) 600V

Available on most GO Switches



Water Resistant Squeeze Connector

Stainless steel water resistant strain relief. Approx. 25 mm (1 in) in length.

Available on GO Switch
Models 72, 74, 76, 7C, 7D, 7E and 7F



High Pressure SubSea Quick Disconnect

Molded Neoprene™ Quick Disconnect with Delrin™ lock-sleeves. Provides water-tight seal, safety and quick change-out. Overall length of connector is 74 mm x 31 mm (2.9 in x 1.23 in) dia.

Available on 10, 20, 70, 80 Series and Stroke to GO Switches.



High Pressure Right Angle SubSea Quick Disconnect

Overall length of connector is 72 mm (2.85 in) x 17 mm x (0.65 in).

Available on 10, 20, 70, and 80 Series and STG GO Switches



Mounting Brackets

Standard mounting brackets are available to cover most GO Switch installations. They are designed to provide secure installation without interfering with the operation of the switch.

Heavy Duty Mounting Bracket

Side mount bracket for 10 Series GO Switches



Universal Mounting Bracket for 10/20 Series

Universal mounting bracket for 10 Series and 20 Series GO Switches



Combination Cover Plate and Mounting Bracket

Bottom mount for 10 or 20 Series GO Switches



Universal Mounting Bracket for 80 Series

Side mount bracket adapts 80 Series GO Switches for rotary valve position indication



Strap Bracket

Strap brackets for 30 Series GO Switches



Heavy Duty "L" Mounting Bracket

"L" bracket for 70 Series Model 73, 74, 75, 76 & 7G GO Switches



Cover Plates

Cover plate for 10 and 20 Series GO Switches. Bottom mount cover plate/conduit for 10 and 20 Series GO Switches. Furnished with gasket and screws



Jam Nuts

Nickel plated brass jam nuts for 70 Series GO Switches



Parker Seal Nut and Washer

ThredSeal Kits for 70 Series GO Switches. Zinc plated steel with nitrile rubber (standard) or Viton (hi-temp or hydraulic fluids detergent) washer



Sealant Tape

Grafoil sealant tape for 70 Series GO Switches. Forms a leak-tight temperature stable joint. Recommended for high pressure and/or high temperature



Target Magnets

Standard magnets are available to increase the sensing distance of any GO Switch model. This feature gives the customer the flexibility of using the magnet as the target and increasing the sensing distance up to 10 times that of ferrous metal targets.

AMP3 Magnet/Resin Cover

AMC3 magnet in plastic molded bracket with mounting holes. 22 mm (7/8 in) x 65 mm (29/16 in) x 13 mm (17/32 in) thick with 6 mm (7/32 in) holes.



For all GO Switches

AMS7 Magnet/Stainless

Magnet assembly. 50 mm (2 in) x 13 mm (1/2 in) 7/16-20 UNC threads.



For 70 Series GO Switches

AMS4 Magnet/Stainless Cover

AMC4 magnet molded into stainless steel cover, with mounting holes. 32 mm (1-1/4 in) x 37 mm (17/16 in) x 25 mm (1 in) thick with 5 mm (3/16 in) holes.



For all GO Switches

AMS12 Magnet

Magnet assembly. 66 mm (2-3/5 in) x 22 mm (7/8 in) 7/16-20 UNF threads.



For 70 Series GO Switches

AMC5 Magnet/Stainless Cover

AMC1 magnet molded into stainless cover with mounting holes. 22 mm (7/8 in) x 65 mm (29/16 in) x 17/32 in (13 mm) thick with 7/32 in (6 mm) holes.



For all square GO Switches

AMF6 Magnet (Machinable)

Flexible sensing amplifier/external magnet. 76 mm (3 in) x 305 mm (12 in) x 3/8 in (10 mm) thick.



For all square GO Switches

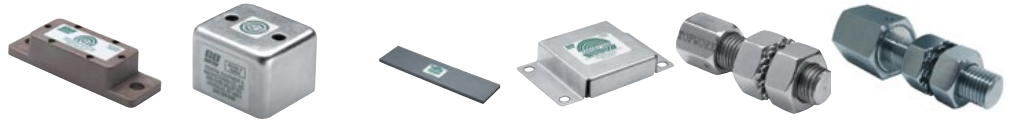

Model	Ferrous Metal Sensing Distance	AMP3 Sensing Distance	AMS4 Sensing Distance	AMF6 Sensing Distance	AMC5 Sensing Distance	AMS7 Sensing Distance	AMS12 Sensing Distance
11	10 mm (3/8 in)	25 mm (1 in)	32 mm (1-1/4 in)	62 mm (2-7/16 in)	86 mm (3-5/8 in)	-	-
21	10 mm (3/8 in)	25 mm (1 in)	35 mm (1-3/8 in)	62 mm (2-7/16 in)	86 mm (3-3/8 in)	-	-
31	6 mm (1/4 in)	19 mm (3/4 in)	25 mm (1 in)	41 mm (1-5/8 in)	67 mm (2-5/8 in)	-	-
71	1 mm (.040 in)	3 mm (.120 in)	4 mm (.150 in)	-	-	3 mm (.130 in)	11 mm (7/16 in)
72	1 mm (.040 in)	3 mm (.120 in)	4 mm (.150 in)	-	-	3 mm (.130 in)	11 mm (7/16 in)
73	2.5 mm (.100 in)	5 mm (.200 in)	9 mm (.350 in)	-	-	5 mm (.200 in)	13 mm (1/2 in)
74	2.5 mm (.100 in)	5 mm (.200 in)	9 mm (.350 in)	-	-	5 mm (.200 in)	13 mm (1/2 in)
75	2.5 mm (.100 in)	5 mm (.200 in)	9 mm (.350 in)	-	-	5 mm (.200 in)	13 mm (1/2 in)
76	2.5 mm (.100 in)	5 mm (.200 in)	9 mm (.350 in)	-	-	5 mm (.200 in)	13 mm (1/2 in)
77	2.5 mm (.100 in)	5 mm (.200 in)	9 mm (.350 in)	-	-	5 mm (.200 in)	13 mm (1/2 in)
7G-1 (SPST)	2.5 mm (.100 in)	5 mm (.200 in)	9 mm (.350 in)	-	-	5 mm (.200 in)	13 mm (1/2 in)
7G-2 (DPDT)	2 mm (.090 in)	4 mm (.150 in)	5 mm (.200 in)	-	-	4 mm (.150 in)	13 mm (1/2 in)
7H	2 mm (.090 in)	4 mm (.150 in)	5 mm (.200 in)	-	-	4 mm (.150 in)	13 mm (1/2 in)
7I	2 mm (.090 in)	4 mm (.150 in)	5 mm (.200 in)	-	-	4 mm (.150 in)	13 mm (1/2 in)
7L	2.5 mm (.100 in)	5 mm (.200 in)	9 mm (.350 in)	-	-	5 mm (.200 in)	13 mm (1/2 in)
81	6 mm (1/4 in)	25.4 mm (1 in)	35 mm (1-3/8 in)	69.8 mm (11/4 in)	98 mm (3-7/8 in)	-	-

GO™ Switch – The all-in-one proximity sensor and limit switch.



TOPWORX™

GO Switch provides reliable, durable proximity sensing in the most demanding conditions. Using unique technology, GO Switch outperforms all other types of sensors in applications that require high reliability and durability. The most versatile sensing solution. It detects like a proximity switch and functions like a limit switch, providing higher reliability when conventional switches fail.

Visit us: [Emerson.com/TopWorx](https://www.emerson.com/TopWorx)

Your local contact: [Emerson.com/contactus](https://www.emerson.com/contactus)

TopWorx and GO - Global Supply Line is the Agent supplier, distributor and stockist. Global Supply Line is the largest Emerson Scotch Yoke Actuator stockist in the southern hemisphere stocking Bettis & Biffi. Scotch yoke pneumatic actuators up to 30,000NM. Click here for our full stock list at our website: <https://www.globalsupplyline.com.au/stock-list-valves/>
Contact us: admin@globalsupplyline.com.au



[Emerson.com/TopWorx](https://www.emerson.com/TopWorx)



[Facebook.com/EmersonAutomationSolutions](https://www.facebook.com/EmersonAutomationSolutions)



[LinkedIn.com/company/Emerson-Automation-Solutions](https://www.linkedin.com/company/Emerson-Automation-Solutions)



[Twitter.com/EMR_Automation](https://twitter.com/EMR_Automation)

The Emerson logo is a trademark and service mark of Emerson Electric Co. Brand logotype are registered trademarks of one of the Emerson family of companies. All other marks are the property of their respective owners. © 2019 Emerson Electric Co. All rights reserved. BR000163ENUS-01_08-20 / Printed in Europe



CONSIDER IT SOLVED™